

## Operating instructions

Vigilon panel and Network node  
Fire detection and alarm system

## Contents

Preface .....	3	How to set the system clock .....	24
Associated Documents .....	3	How to use the integral printer .....	25
Conventions .....	3	To Switch On / Off the Printer .....	25
Symbol Keys .....	3	To action a Paper Feed .....	25
Abbreviations .....	3	To conduct a Printer Test .....	25
User responsibility .....	4	How to enable/disable Sensing .....	25
Daily .....	4	How to enable/disable a zone .....	26
Weekly .....	4	How to manually switch On / Off FARE .....	26
Limitation of false alarm .....	5	How to manually Disable / Enable FARE .....	27
Control and indicating equipment .....	5	How to manually Disable / Enable FPE .....	27
Control panel .....	5	How to enable/disable an IO line .....	28
Network Node .....	6	How to enable/disable auxiliary relay .....	28
Repeat panel .....	6	Other enable/disable options .....	29
Zonal Mimic panels .....	6	How to view a device label .....	29
Description of controls and indications .....	7	How to view a zone label .....	30
Normal condition .....	11	How to view a I/O line label .....	30
How to operate a 'U' button .....	11	How to view the local panel label .....	31
Weekly tests .....	12	To view or print a map .....	31
How to manually raise an alarm of FIRE .....	13	Editing labels .....	32
Automatic detection of FIRE .....	14	How to edit a device label .....	32
Fault conditions .....	16	How to edit an Input/output line label .....	33
Typical fault messages .....	17	How to edit a zone label .....	34
Disablement conditions .....	18	How to edit a local panel label .....	34
Typical Disablement Messages .....	19	How to edit custom label .....	35
Menu controls .....	20	Maintenance .....	36
To carry out a display test .....	21	Replacing the glass on a Manual Call Point .....	36
How to change your PIN code .....	21	Resetting the resettable element on a Manual Call Point .....	36
How to view the historic events .....	22	Battery replacement .....	37
Cards inside the control panel .....	22	Replacing printer paper .....	37
How to save changes to memory .....	23	Repair function .....	38
How to view active events .....	23		

## Preface

This is the second issue of the operating instructions for the Vigilon panel based fire detection and alarm system having the 2km loop cards. It covers Fire Alarm Routing Equipment and Fire Protection Equipment controls.

## Associated Documents

Vigilon panel based system  
 - Installation instructions  
 - Log Book

## Conventions



**This is a note to highlight important text that is normally hidden in the main text.**



**This is either a caution to prevent damage to the equipment or a warning to inform of dangerous conditions that may result in injury or death.**

## Symbol Keys



What you will see.



What you will hear.



A fire condition.



On

LED illuminated - On.



Flashing

LED illuminated - Flashing.



Not applicable

## Abbreviations

FARE	Fire Alarm Routing Equipment
FPE	Fire Protection Equipment
LED	Light emitting diode (light)
MCP	Manual call point
NVM	Non Volatile Memory
OC or O/C	Open circuit
IO or I/O	Input or Output
SC or S/C	Short circuit
<b>[Text]</b>	Denotes menu option that appears on display
<b>Text</b>	Denotes physical keys on keypad

## User responsibility

Your fire alarm system should have been designed, installed and commissioned to your site specific requirements and in accordance with the requirements of BS5839 Part 1. You should have received instructions about your system during the handover stage and must make arrangements to ensure the system is regularly tested and maintained.

It is recommended that the person responsible for the fire alarm system should ensure the system is tested and maintained in accordance with the requirements of BS 5839 : Part 1 and become familiar with:

- ▣ the operation of controls and be able to interpret the indications given at the control panel
- ▣ keep up to date all documentation associated with the system.



**Any servicing work on the Vigilon system must be carried out by a suitably trained person, please refer to your servicing organisation.**

## Daily

*BS 5839 : Part 1*, states that the system should be inspected daily to ensure:

- ▣ That a normal indication is given at the control and indicating equipment.
- ▣ That any previously indicated fault conditions have received appropriate attention.
- ▣ All system events are entered into the Log Book for future reference.
- ▣ That the use of the 'area(s) that are inspected' has not changed since the system was designed.
- ▣ That no unsafe practices that could lead to fire are being undertaken.

## Weekly

When testing the system there may be a need to isolate ancillary outputs and it is important to contact the alarm receiving centre before and after the weekly test.

- ▣ A different manual call point of the system should be tested to ensure the system is capable of operating under alarm conditions.
- ▣ The operation of the alarm sounders should be checked, which also reminds the occupants that there is a fire alarm system which gives a particular sound and visual output.



**The test should be performed at a regular time to avoid confusion between a test and a genuine fire alarm. The alarm receiving centre must be contacted before and after the test to check alarms are received and also to avoid unwanted alarms.**

## Quarterly

At quarterly intervals the system should be inspected and any work necessary should be performed by a trained maintenance engineer.



**For help with service and maintenance please refer to your servicing organisation, see contact details entered in the log book.**

## Limitation of false alarm

It is recommended that the person responsible for the fire alarm system should arrange for suitable investigation and appropriate action on occasion of every false alarm. For a system having less than 40 automatic fire detectors installed, an in-depth investigation should be instigated on occurrence of two false alarms in any rolling 12 months. For a system having more than 40 automatic fire detectors an investigation should be instigated if there has been:

- ▣ one false alarm for every 20 installed detectors in the system in any rolling 12 months, or
- ▣ two or more false alarm occurrences from a single device.

## Control and indicating equipment

On occurrence of a fire, fault or disablement event in the protect premises, the event is quickly indicated at a control and indicating equipment. The control and indicating equipments are installed in accessible location and can be operated by the person responsible for the fire system.

## Control panel

The control panel is the heart of the system. It is normally located near to the main entry or exit point of the protected premises.

The control panel continuously monitor devices that are connected to each device loop. The device loop cable is routed through the protected premises to cover all areas with both ends of the loop terminating at the control panel. On the loop cable are installed devices such as fire sensors, that constantly monitor the environment for fire. Alarm devices on the loop provide alert and evacuation alarm to warn occupants in the protected premises in the event of a fire.



Control panel (with zone indicators)  
Network node (has no zone indicators)

### Network Node

A Network node provides central indications of events in a Vigilon network.



Some operations identified by the symbol 'NA' covered in this manual are not applicable for the Network Node.

### Repeat panel

There may be one or more repeat panels installed in the protected premises to provide secondary indications of the system condition. The larger repeat panel additionally provide system controls. The repeat panels are usually located near to secondary entry and exit points of the protected premises.



Repeat panel  
(provides system indications and controls)



Repeat indicator panel  
(provides system indications)

### Zonal Mimic panels

There may also be a number of mimic and zonal mimic panels installed in the protected premises, to provide visual indications in a graphical and zonal format.

Normally one is installed next to the main control panel. There may be additional Zonal mimic panels installed in other areas of the protected premises to cover sub division of the premises.



A3 Zonal panel  
(Provides zonal indication of events)

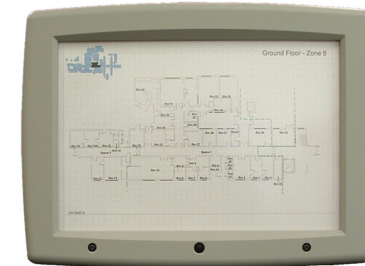

A3 Mimic panel  
(Provides location indication of area(s) on a plan where event(s) have occurred)

# Description of controls and indications

Open the front door to reveal the controls.

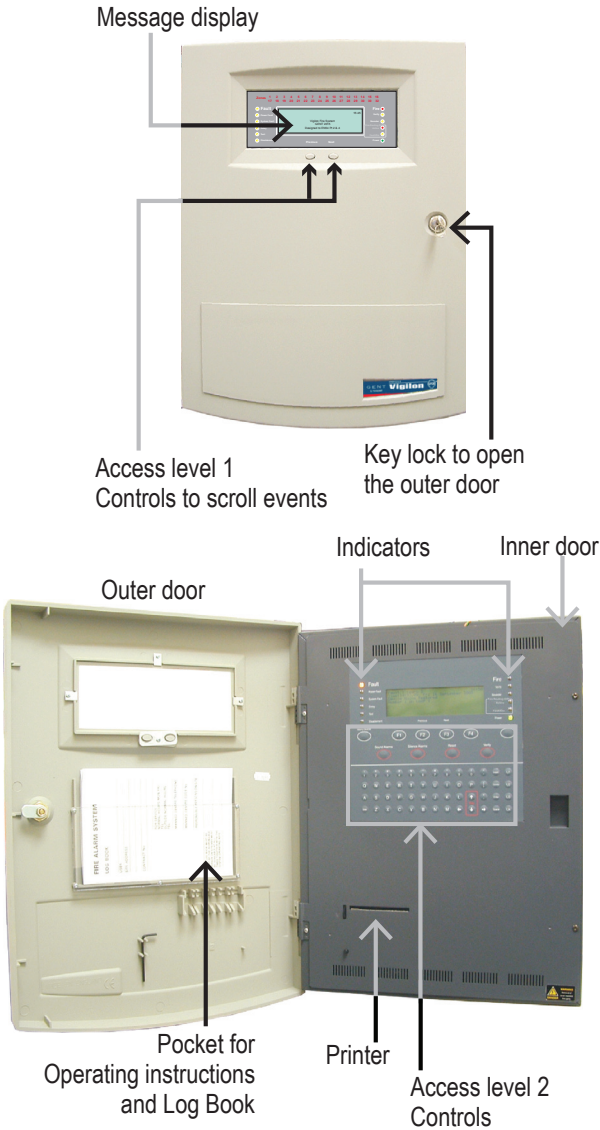







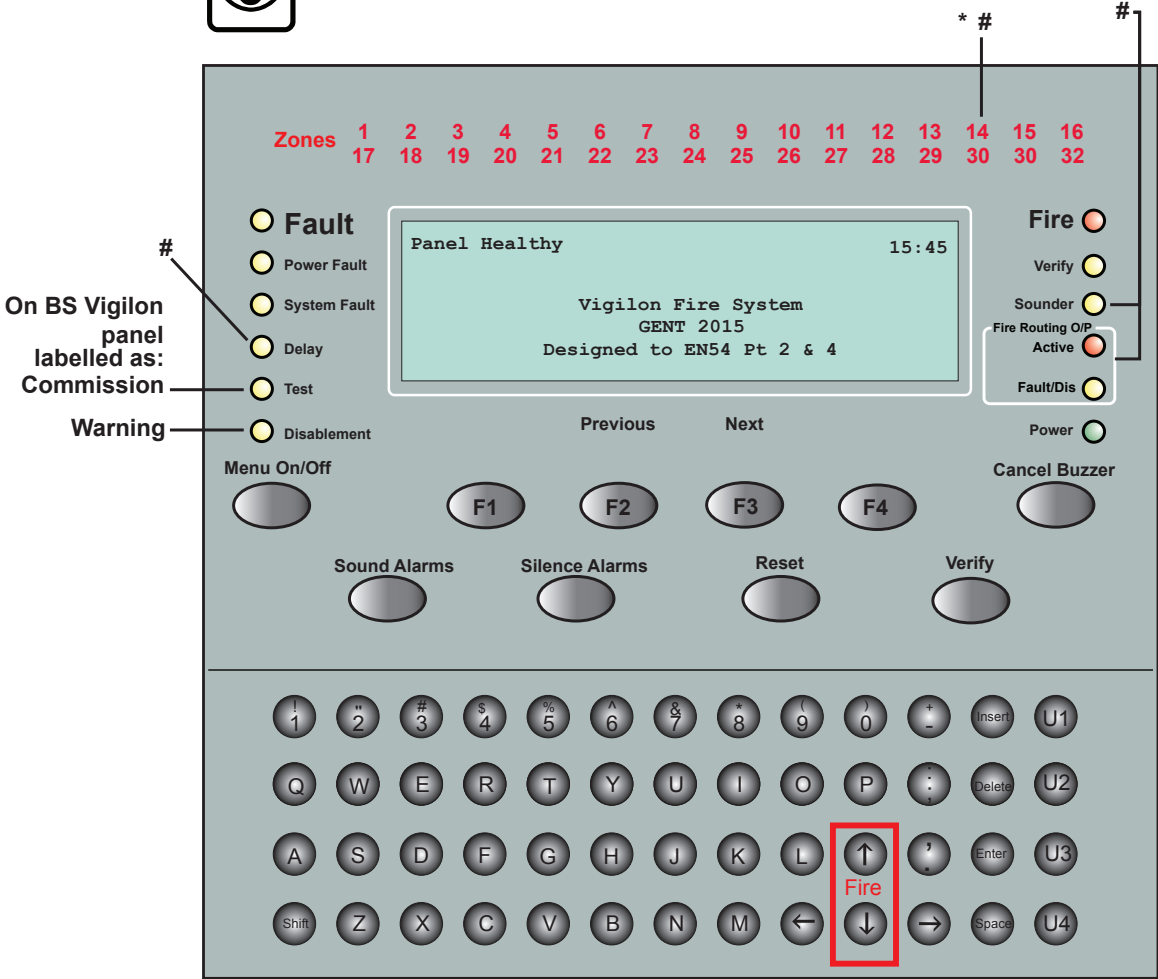





## EN Vigilon 4-loop panel Network Node or BS Vigilon 4-loop panel











\* NOT applicable for Network Node  
# NOT USED on BS Vigilon panel





## Description of controls and indications

<b>Indicators</b>	<b>Description</b>
<i>Display</i>	<i>The Display provides messages of the system status / events by means of 8 lines by 40 characters per line display.</i>
<b>Zones</b>  (red)	Secret-until-lit fire zone indicators. When the “Zones” text and number(s) are illuminated it indicates that a FIRE has been detected in the indicated zone(s).   The Zone indicators are not applicable for a Network node.
<b>Power</b>  (green)	When illuminated it indicates that a supply to the panel is present.
<b>Fire</b>  (red)	When illuminated it indicates that a FIRE has been detected in the protected premises.
<b>Verify</b>  (amber)	When illuminated it indicates that the Verify button has been pressed and the alarm sounders in the system are delayed from sounding.
<b>Fault</b>  (amber)	When illuminated it indicates that a FAULT has been detected in the fire detection and alarm system.
<b>System Fault</b>  (amber)	When illuminated it indicates that a fault has occurred with the system processor. It is important to investigate this fault because the fire system may not be able to detect fires.
<b>Disablement</b>  (amber)	When illuminated it indicates that a part of the system has been disabled.
<b>Active</b>  (red)	When illuminated it indicates the Output to the Fire Alarm Routing Equipment is active.
<b>Fault/Dis</b>  (amber)	When illuminated flashing (always with the DISABLEMENT light) it indicates the Output to Fire Alarm Routing Equipment is disabled.
<b>Fault/Dis</b>  (amber)	When illuminated steady (always with the FAULT light) it indicates that there is a fault at the Fire Alarm Routing Equipment).
<b>Power Fault</b>  (amber)	When illuminated it indicates the battery or mains supply to the panel has failed.
<b>Sounder</b>  (amber)	When illuminated (always with either the FAULT light or the DISABLEMENT light) it indicates that there is a sounder fault (flashing indication) or sounder disablement (steady indication).

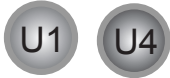

<b>Indicators</b>	<b>Description</b>
Sounder  (amber)	When illuminated it indicates that one or more delay blocks are setup on the panel.
Test  (amber)	When illuminated it indicates one or more zones are in Test mode.
<b>Controls</b>	<b>Description</b>
Menu On/Off 	Pressing the <b>Menu On/Off</b> will enable/disable the on screen menu facility, which gives access to the system menus.
	The ' <b>Fn</b> ' buttons are used to select a function and sub functions at the panel menus that appear on the display. Each option in the menus corresponds to one of the function buttons and pressing a button will select the option which appears above it on the display.
Cancel buzzer 	The <b>Cancel Buzzer</b> button when pressed will stop the internal panel buzzer from sounding.
Sound alarms 	Pressing the <b>Sound Alarms</b> button will sound all the system alarms. This button is only pressed in an emergency or at other agreed times, for example when conducting a sounder test or practice evacuation.
Silence alarms 	Pressing the <b>Silence Alarms</b> button will silence the system alarms.
Reset 	Pressing the <b>Reset</b> button will clear any fires and return the panel to its normal condition. If a fire condition occurs immediately after reset then the indicated device should be investigated.

## Description of controls and indications

<b>Controls</b>	
	<p>If the <b>Verify</b> facility has been set up, then pressing the Verify button in the event of a fire condition, increases the time delay before the sounders are activated. This gives the user time to investigate the cause of the alarm and the option of cancelling the alarm within the delay time period.</p>
	<p>These buttons can be configured during commissioning to action user-defined tasks, such as the disablement of devices in areas where smoke may be generated due to maintenance work or where plant shutdown is required.</p>
	<p>The two 'fire events' scroll buttons on the keyboard operate in exactly the same way as the two first level access fire scroll buttons on the front door. These buttons are active when the door is open.</p>
<p>Qwerty keypad</p>	<p>Allows the entry of alphanumeric data at the panel, such as a label given to a zone or device.</p>
	<p>This button is pressed to acknowledge an entry of data such as a label.</p>

## Normal condition

When a system is operating normally with no fault or disablement present then the panel's display shows:

- 'Panel healthy' message and 'Network Healthy' message at a network node and
- only the 'Power' *green* indicator is lit.

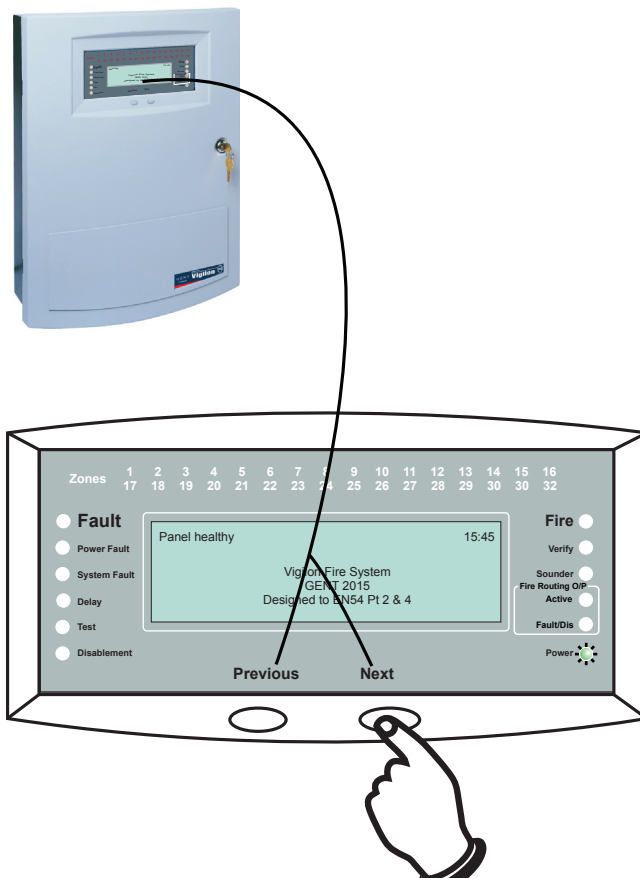

The FIRE events when displayed can be scrolled through by utilising the first level controls located as shown on the panel front door.

## How to operate a 'U' button

The U1 to U4 buttons may have been configured during commissioning to action user-defined tasks, such as the disablement of devices in areas where smoke may be generated due to temporary maintenance work or to action a plant shutdown if required.

The function of these 'U' buttons should be written on the label that is fitted on the back of the panel's outer door.

- With the panel door open:

*To activate a 'U' button task.*

*You can activate the predefined task by operating a 'U' button.*



*Press:  
n - can be 1 to 4.*

## Weekly tests

Every week during normal working hours the fire detection and alarm system should be tested. It is important to inform the alarm receiving centre of the fire test.

The weekly fire test can be carried out at a manual call point without breaking the call point glass.

- Insert the test key into the keyhole located on the bottom-centre front face of the call point and turn the key one quarter of a turn clockwise.



The 'Zone indicators' are not applicable for Vigilon Network Node

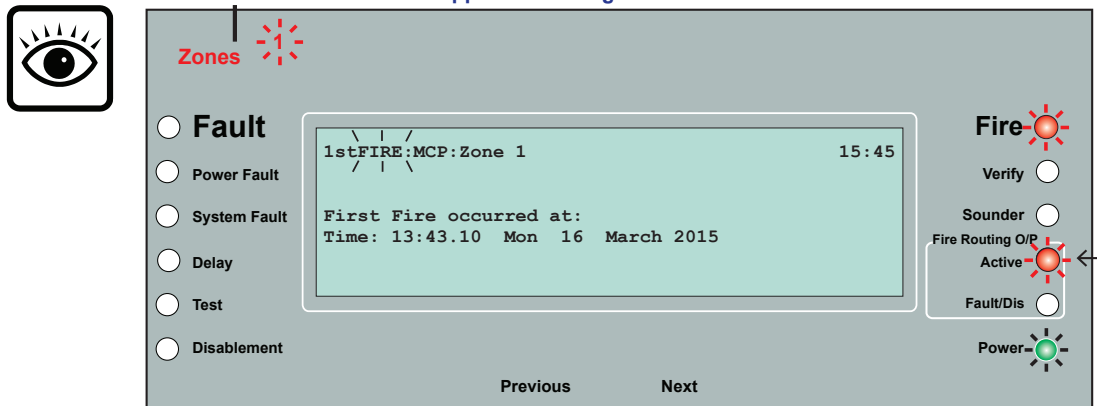

If applicable it indicates there is active Fire routing output to Alarm Receiving Centre. Who would know this is a test as they would have been advised before the weekly test.

At this point the test key is retained in the call point.

- Check the alarms are sounding in the building and an indication is given of the fire event.
- Turn the test key anticlockwise one quarter of a turn and remove it from the call point.
- With the panel door open:

To cancel buzzer

You can stop the panel buzzer from sounding.



Press:

Display reads: 'Buzzer cancelled'

To silence alarms

When the test is complete, the alarm sounders can be silenced.



Press:

Display reads: 'Alarms silenced'

To reset system

To return the system to normal condition clear any residual smoke or heat from sensors and reset element or replace the glass in any manual call point where the glass was broken.



Press:

Display reads 'System being Reset - please wait....'

Record the event

Make an entry in the log book of the event for future reference.

## How to manually raise an alarm of FIRE



If you see a fire in the protected premises and want to raise a fire alarm to warn occupants in the building, you can do this manually by:

- Going to the nearest manual call point that is located away from the fire hazard.
- Press hard with a thumb onto the centre of the glass until it breaks.

Manual Call point

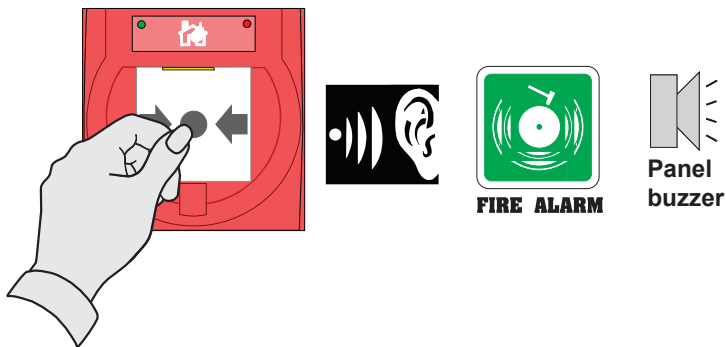

The 'Zone indicators' are not applicable for Vigilon Network Node

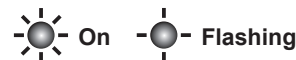

If configured this light indicates there is an active Fire routing output to Alarm Receiving Centre to initiate Fire fighting action.

- With the panel door open:

To cancel buzzer

You can stop the panel buzzer from sounding.

Cancel buzzer



Press:

Display reads: 'Buzzer cancelled'

To silence alarms

When the emergency is over the alarm sounders can be silenced.

Silence alarms



Press:

Display reads: 'Alarms silenced'

To reset system

To return the system to normal condition clear any residual smoke or heat from sensors and reset element or replace the glass in any manual call point where the glass was broken.

**Ensure the fire system is checked by your servicing organisation if there has been fire damage in the protected area.**

Reset



Press:

Display reads 'System being Reset - please wait...'

Record the event

Make an entry in the log book of the event for future reference.

## Automatic detection of FIRE



A fire in your protected premises is automatically sensed at any one of the fire detection devices installed in the building, such as a sensor or a fire input from an interface. The control panel actions the alarm sounders in the system and at the same time gives the details of the fire event. The event indication is repeated at all repeat indicator panels in the system.

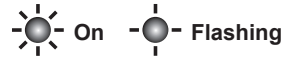

The 'Zone indicators' are not applicable for Vigilon Network Node

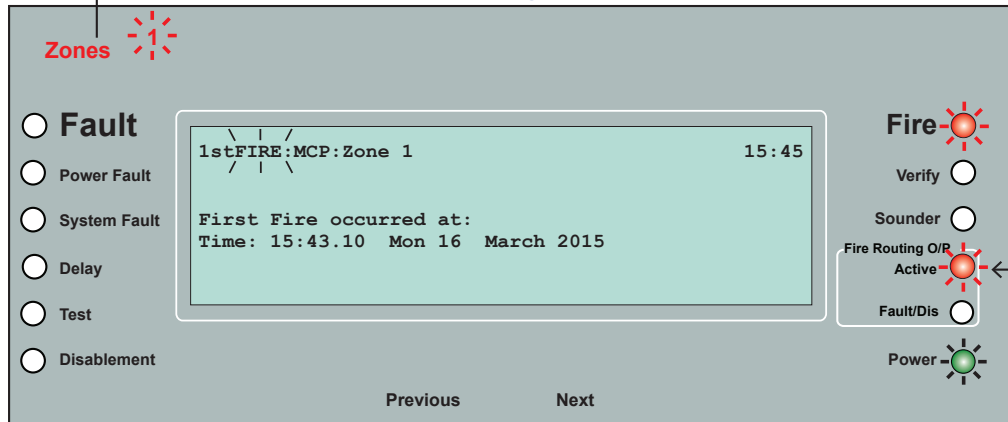

If configured this light indicates there is an active Fire routing output to Alarm Receiving Centre to initiate Fire fighting action.

### With the panel door open:

To cancel buzzer

You can stop the panel buzzer from sounding.

Cancel buzzer



Press:

Display reads: 'Buzzer cancelled'

To silence alarms

When the emergency is over the alarm sounders can be silenced.

Silence alarms



Press:

Display reads: 'Alarms silenced'

To reset system

To return the system to normal condition clear any residual smoke or heat from sensors and reset element or replace the glass in any manual call point where the glass was broken.

**Ensure the fire system is checked by your servicing organisation if there has been fire damage in the protected area.**

Reset



Press:

Display reads 'System being Reset - please wait....'

Record the event

Make an entry in the log book of the event for future reference.

*Multiple fires*

Previous



Next

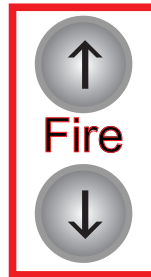

Use the [Previous] or [Next] buttons or with the outer door open you can to scroll the fire events.  
The 1st Fire will always appear at top of display. All subsequent fires appear beneath the 1st Fire.

**Zones**  The zonal indicators show zones in fire condition. If the panel is configured, the first zone to go into a fire condition may be indicated by a flashing zone number, all other zones in fire give a steady indication.

A square icon with rounded corners containing the letters 'NA'.

The zone indicators are not applicable for Network Node.

Each fire is logged in the Historic Events log, which can be recalled using the menus. See How to view the Historic Events.

To verify an alarm  
(If required by  
site procedures)

Upon receipt of a fire condition the alarm sounders in the system can be delayed from sounding by using the Verify button.  
This allows time to investigate the cause of the alarm.  
Note the delayed sounders will operate after the verify period has timed-out.



Press:



## Fault conditions

### Fault conditions

A fault in the system, such as failure of mains power to the panel or removal of any monitoring device will cause a Fault condition to appear at the control panel. The control panel will provide details of the event, this event indication is repeated at all repeat panels and may also be displayed at zonal and mimic panels in the system.

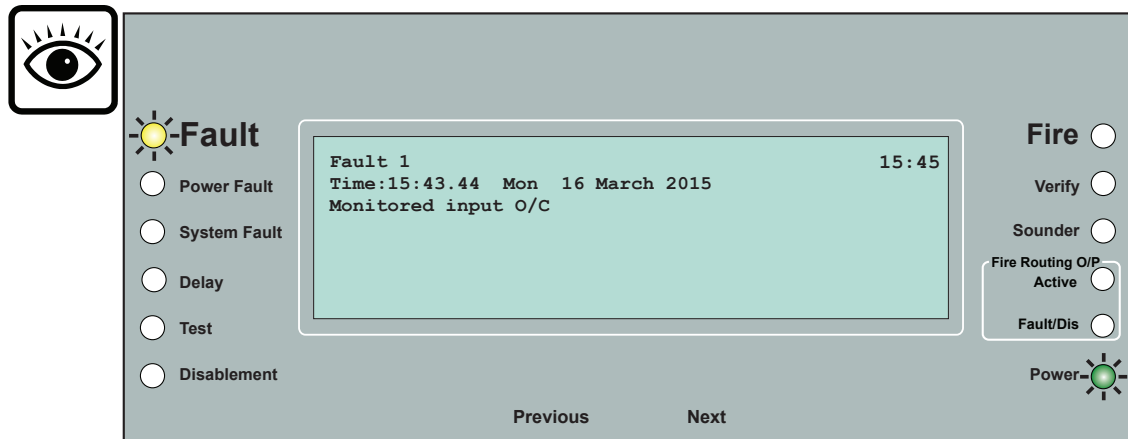
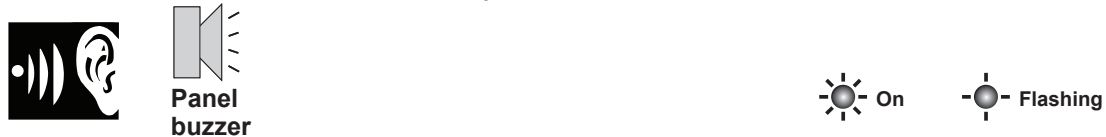

### With the panel door open:

To cancel buzzer

You can stop the panel buzzer from sounding.



Press:

Display reads: 'Buzzer cancelled'

What must be done?

You need to ensure the panel is returned to normal condition. All fault repairs must be undertaken by engineers responsible for the system. Refer to the contact details in the log book.

Record the event

Make an entry in the log book of the event for future reference.

Multiple faults

The number 'n' following the word 'Fault' located top left on the display denotes the number of faults present in the system. Each fault is logged in the Historic Events log, which can be recalled using the menus. See How to view the Historic Events.



















**Only the trained engineer who is responsible for the fire alarm system must attempt any fault rectification work. For advice please call your servicing organisation, see contact details in the Log book.**



## Typical fault messages

The table below shows some of the more typical fault messages and indications that may appear at the panel if there are faults in the system. It also gives the meaning and possible rectification action for each fault.

 On  Flashing

Message	Indication	Meaning	Action
FARE Faulty	<b>Fault</b>  Fault/Dis 	The Fire Alarm Routing Equipment FARE is faulty.	Check short circuit or signal transmission failure at FARE
Mains failed	<b>Fault</b>  Power Fault 	The mains supply to the control panel has failed.	Restore the mains supply to the control panel.
Battery discharged n	<b>Fault</b>  Power Fault 	The battery supply to the Control Panel is fully discharged.	Check the battery and replace if necessary.
Battery disconnected	<b>Fault</b>  Power Fault 	The battery supply to the Control Panel has been disconnected.	Reconnect the battery.
Monitored line input OC or SC	<b>Fault</b> 	The monitored line input has an open or short circuit fault.	Check the wiring and ensure the end-of-line device is connected in the circuit.
Master Alarm(s) OC or SC n	<b>Fault</b>  Sounder 	There is an open or short circuit fault on the master alarm wiring.	Check the wiring. Ensure the end-of-line device is connected in the circuit.
Lost Device	<b>Fault</b>  Sounder 	The Device is not communicating with the Control Panel via the Loop. Additional indication given if it is a Sounder device.	Check the connections to the device.
Wiring changed SC at card n	<b>Fault</b> 	There is a short circuit on the loop n wiring.	Identify the device where a cable fault has occurred and remove the fault.
Interface input OC /SC	<b>Fault</b> 	There is an open or short circuit on the input line of an interface.	Locate and remove the wiring fault. Ensure the end-of-line device is connected in the circuit.
Device Mains failed	<b>Fault</b> 	There is a mains supply failure at an interface unit, repeat panel or mimic panel	Check the fuse and mains supply to the equipment.
Device Battery fault	<b>Fault</b> 	The battery supply at an interface unit, repeat panel or mimic panel has failed the load test.	Check the battery and replace if necessary.

## Disablement conditions

A disablement condition is the manual or automatic disablement of a part of the fire detection system. An automatic disablement may be pre-configured for your premises to disable smoke sensors during the normal working hours in areas where smoke or dust may be present. A manual disablement may be necessary where temporary building work is being undertaken that could result in a false alarm.

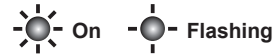













This indication is only given if a sector, sounder device or master alarms in the system are disabled.

<i>What must be done?</i>	<i>Investigate the reason for the disablement and re-instate the devices if appropriate.</i>
<i>Record the event</i>	<i>Where necessary make an entry in the log book of the event for future reference.</i>
<i>Multiple Disablements</i>	<i>The number 'n' following the word 'Disable' located top left on the display denotes the number of disablements present in the system. Each disablement is logged in the Historic Events log which can be recalled using the menus, see How to view the Historic Events.</i>

## Typical Disablement Messages

The following table shows some typical disablement messages and indications that may appear at the panel.

 On    Flashing

Message	Indication	Meaning	Action
FARE Disabled	<b>Fault</b>  <b>Fault/Dis</b> 	The Fire Alarm Routing Equipment FARE has been Disabled.	If manually disabled then investigate and if necessary re-enable FARE.
Zone Disabled at card n	<b>Disablement</b>  <b>Fault/Dis</b> 	The zone specified has been manually or automatically disabled.	If manually disabled then investigate and if necessary re-enable the zone.
Device disabled at card n	<b>Disablement</b>  <b>Sounder</b> 	The device connected to the loop circuit has been manually or automatically disabled. Additional indication is given if it is a sounder device.	If manually disabled then investigate and if appropriate re-enable the device.
Sector disabled at card n	<b>Disablement</b>  <b>Sounder</b> 	The fire alarm sector on loop n has been manually or automatically disabled.	If manually disabled then investigate and if appropriate, re-enable the sector.
Disabled Aux Relay n	<b>Disablement</b> 	The auxiliary relay n in the control panel has been manually or automatically disabled.	If manually disabled then investigate and if appropriate, re-enable the aux relay.
Master alarm(s) disabled	<b>Disablement</b>  <b>Sounder</b> 	The master alarms have been manually or automatically disabled.	If manually disabled then investigate and if appropriate, re-enable the master alarms.



Any changes to the setting of an automatic disablement must only be attempted by a trained engineer who is responsible for the fire alarm system, see contact details in the Log book.

## Menu controls



 Panel beeps on button press

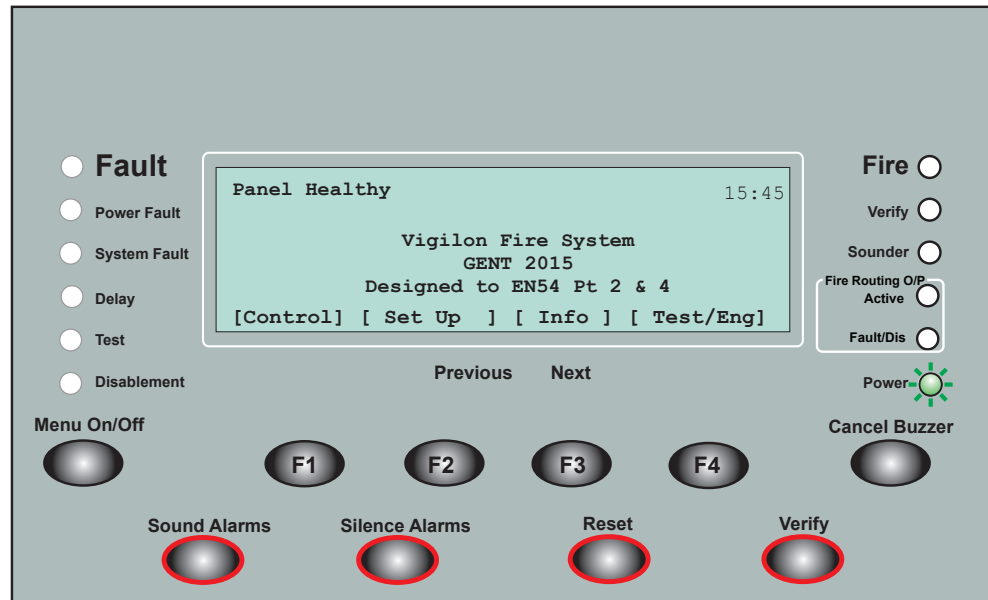

The **MENU ON/OFF** button activates the function keys F1 to F4 for the selection of menu prompts that appear above the function keys on the display.

At any level in a menu, single press of the **MENU ON/OFF** key aborts an operation. However as an alternative the **[Quit]** option can be selected to exit the function mode.

If the time taken between key presses exceeds five minutes, then the control panel will automatically remove the menu options from the display and give a system status indications.

The **[Params]** option is a Help function to provide information to the user regarding the type of input data required.

Most of the functions in the **[Control]**, **[Setup]** and **[TestEng]** menu options are protected with password entry. The password is programmed during the commissioning of the system and is passed on to the site person responsible for the fire alarm system.



**An open access to controls under User code is undesirable, so it is recommended that a customer password is setup.**

Where a **password** code is not set up, there is an open entry to operate the controls under **[User Code]**. Where this is true the instructions for entering the access code, password (or PIN) in the following instructions should be ignored.

## To carry out a display test

You can test the message display and the indicators on the control panel.

- a. Press the **MENU ON/OFF** key and then the F4 key to select **[Test/Eng]**.
- b. Press the F1 key to select **[Disp Test]**. Check that the following things happen: The display clears, the indicators illuminate, the buzzer sounds two distinct tones and then the display shows the system status message. The display test lasts for about 4 seconds.

## How to change your PIN code

The following terms: Password, PIN, Usercode and Access code mean the same and are used interchangeably.

A Customer user PIN code (password) is normally set up by the servicing organisation during commissioning of the fire alarm system. The customer PIN code is set up for the end user. The person responsible for the fire alarm system should be aware of this PIN code. For security the PIN should be changed on a regular basis.

A previously created PIN can be changed:

- a. Press the **MENU ON/OFF** button.
- b. Press the F4 button to select **[Test/Eng]**.
- c. Press the F4 button to select **[UserCode]**. Use the keypad to input your existing access code and then press the **Enter** button.
- d. Press the F1 button to select **[NewPass]**. At the flashing cursor using the keypad input the PIN code and press the **Enter** button. Notice 'New access code set up' appears on the display.



**Any changes made to the PIN code must be backed-up to the panel memory. If this is not done then the previous PIN is restored on resetting the panel, see section on 'How to save changes to memory'. It is not necessary to backup the password at a repeat panel.**

### How to view the historic events

Up to 255 events are stored in the Historic log of the panel. To view the Historic log.

- a. Press **MENU ON/OFF**.
- b. Press the F3 button to select **[Info]**. *Ignore step c. if an external printer is not fitted or is switched off.*
- c. To display the event(s): Press the F1 button to select **[Display]**. Notice 'Display' appears on the display. To print the event(s): Press the F2 button to select **[Print]**. Notice 'Print' appears on the display.
- d. Press the F2 button to select **[Historic]**. Notice 'Historic' followed by a flashing cursor appears on the display.
- e. Use the keypad to input an event number 1 to 255. If you want to view events at another node in a networked system, then you will need the node number. Select **[Node]** and enter the node number.



**The event number '1' is always the most recent event.**

- f. Press the F2 button to select **[Enter]**. Notice the required event(s) are displayed or printed depending on your selection.

### Cards inside the control panel

The control panel uses the following card reference numbers.

- ▣ **Card 0** is always the **Main controller card (MCC)**, also referred to as a local controller.
- ▣ **Cards 1 to 4 #** are always loop cards, that monitor and control the devices on loop circuits within the protected premises.

# A 6 loop Vigilon control panel VIG1-72 has a larger capacity and can have up to 6 loop cards fitted, the additional loops occupy positions **Card 5** and **Card 6**.



The loop cards are not applicable for Network Node.

- ▣ **Card 14** is always the memory that resides on the **Backplane**.

## How to save changes to memory

If you make any changes to a Labels or Password then you must save these to the NVM (Non Volatile Memory) or Memory of the panel.



**Changes made to labels and password can be saved to the panel memory (NVM), this can only be done when there are no disablements present on the system.**

The following procedures assume a customer password (PIN) is setup at the panel.

- a. Press the **MENU ON/OFF** button.
- b. Press the F2 button to select **[Set Up]**.
- c. Press the F4 button to select **[UserCode]**. At the flashing cursor using the keypad input your PIN code and then press the **Enter** button.
- d. Press the F4 button to select **<etc>** and then press the F3 button to select **[Save]**.



**The 'Save' option is only available if Access level 2 PIN is set up.**

- e. Press the F2 button to select **[Enter]**. Observe confirmation of data backed up.

## How to view active events

An active event is an event that is still present and has not cleared. You can view all active Fire, Fault or Disablement events.

- a. Press **MENU ON/OFF**.
- b. Press the F3 button to select **[Info]**. *Ignore step c. if an external printer is not fitted or is switched off.*
- c. To display the event(s): Press the F1 button to select **[Display]**. Notice 'Display' appears on the display. To print the event(s): Press the F2 button to select **[Print]**. Notice 'Print' appears on the display.
- d. Press the F1 button to select **[Active]**. Notice 'Active' appears on the display. To view events on the local panel and on a card by card basis then press the F3 button to select **[Card]**, notice 'on card' appears on the display. Enter the card number. To view events at another node in a networked system, then you will need to know the node number. Press the F4 button to select **[Node]** and enter a node number from a range 1 to 255.
- e. Press the F2 button to select **[Enter]**. Notice all of the active Fire, Fault and Disablement events are displayed in turn. Press the F2 **[Previous]** and F3 **[Next]** button to scroll through the displayed events.
- f. Press the F4 button to select **[Quit]**, when viewing of events is complete.

## How to set the system clock



**An incorrect setting of the system clock will affect any time related sensor configuration and consequently results in incorrect event time information.**

- a. Press the **MENU ON/OFF** key and then the F2 key to select **[Set Up]**.
- b. Press the F4 key to select **[User Code]**. At the flashing cursor using the keypad input the PIN code and press the **Enter** button.
- c. Press the F1 key to select **[Set Clock]**. The system clock is displayed on the screen. Check the hour digits are flashing.
- d. Press the F2 or F3 key to **[Retard]** or **[Advance]** to the desired setting.
- e. Press the F1 key to select **[Next]**. Check that the Minute digits are now flashing.
- f. Press the F2 or F3 key to **[Retard]** or **[Advance]** to the desired setting.
- g. Press the F1 key to select **[Next]**. Check that the Date digits are now flashing.
- h. Press the F2 or F3 key to **[Retard]** or **[Advance]** to the desired setting.
- i. Press the F1 key to select **[Next]**. Check that the Month digits are now flashing.

- j. Press the F2 or F3 key to **[Retard]** or **[Advance]** to the desired setting.
- k. Press the F1 key to select **[Next]**. Check that the Year is now flashing.
- l. Press the F2 or F3 key to **[Retard]** or **[Advance]** to the desired setting.
- m. Press the F4 key to select **[Enter]**. Check that the display now shows the new time and date.



**Any changes made to the time and date will be automatically sent to the repeat panels in the system. The system clock adjusts automatically for Day light saving, if set up during commissioning. Now 'Save' the changes made to the clock settings.**



## How to use the integral printer

Assuming the panel has an integral printer:

### To Switch On / Off the Printer

- Press the **MENU ON/OFF** key.
- Press the F1 key to select **[Control]**.
- Press the F3 key to select **[Printer]**. Check that 'Printer' appears on the screen.
- Press the F3 key to select **[On]** / **[Off]** and then press the F2 key to select **[Enter]**. 'Printer is on/off' is displayed.

### To action a Paper Feed

- Press the **MENU ON/OFF** key.
- Press the F1 key to select **[Control]**.
- Press the F3 key to select **[Printer]**. Check that 'Printer' appears on the screen.
- Press the F2 key to select **[Paper Fd]**. Note the display and menu prompts are cleared. Printer performs 8 line feeds.

### To conduct a Printer Test

- Press the **MENU ON/OFF** key.
- Press the F1 key to select **[Control]**.
- Press the F3 key to select **[Printer]**. Check that 'Printer' appears on the screen.
- Press the F1 key to select **[Test]**. Note the display and menu prompts are cleared.
- Check that the printer provides a listing of all the characters it is capable of printing.

## How to enable/disable Sensing

 *These operations are not applicable for a Network Node.*



**It is only possible to disable a Manual Call Point (MCP) individually, not as part of a range. DISABLING A MCP IS NOT RECOMMENDED.**

A sensing device such as a sensor or MCP in the system can be disabled/enabled. You will need the device and loop numbers, this information can be found in the site specific documents held by the person responsible for the fire system.

- Press the **MENU ON/OFF** key.
- Press the F1 button to select **[Control]**.
- Press the F4 button to select **[UserCode]**. At the flashing cursor using and the keypad input your PIN code and then press the **Enter** button.
- To disable a device: Press the F2 button to select **[Disable]**. To enable a device: Press the F1 button to select **[Enable]**. The display shows either 'Enable' or 'Disable'.
- Press the F1 button to select **[Sensing]**. Notice 'Device' followed by a flashing cursor appears on the display. Use the keypad to input a device number or range (1-200).
- Press the F2 button to select **[Loop]**. Notice 'Loop' followed by a flashing cursor on the display. Use the keypad to input a loop number or range (1-2).
- Press the F2 button to select **[Enter]**. This is confirmed by: 'Device(s) enabled' or 'Device(s) disabled'. The Disablement light is lit upon disablement of the device.

## How to enable/disable a zone

**NA** *These operations are not applicable for a Network Node.*

A zone is a subdivision of your premises that is protected by the fire alarm system. There can be up to 128 zones configured in a system. Any zone operation can be disabled or enabled. You will need to know the zone number, this can be found in the site specific documentation held by the person responsible for the fire alarm system. From the panel:

- a. Press the **MENU ON/OFF** key.
- b. Press the F1 button to select **[Control]**.
- c. Press the F4 button to select **[UserCode]**. At the flashing cursor using the keypad input your PIN code and then press the **Enter** button.
- d. To disable a zone: Press the F2 button to select **[Disable]** or press the F1 button to select **[Enable]**.
- e. Press the F4 button to select **<etc>** and then press the F2 button to select **[Zone]**. At the flashing cursor using the keypad input a zone number or range (1-128).
- f. Press the F2 button to select **[Enter]**. Notice the action has been processed and a message appears on the display 'Zone n enabled' or 'Zone n disabled'. The Disablement light will be illuminated upon disablement of any zone.

## How to manually switch On / Off FARE

The fire alarm routing output via the FARE interface that signals the Alarm Receiving Centre can be manually switched On/Off. It may be necessary to switch FARE to initiate fire fighting action. From the panel:

- a. Press the **MENU ON/OFF** key.
- b. Press the F1 button to select **[Control]**.
- c. Press the F4 button to select **[UserCode]**. At the flashing cursor using the keypad input your PIN code and then press the **Enter** button.
- d. Momentarily press the F4 button to select **<etc>** until **[FARE]** option is displayed.
- e. Press the F4 button to select **[FARE]**.
- f. To switch On or Off signal to Fire Alarm Routing Equipment: Press the F1 or F2 button to select **[Off]** or **[On]**.
- g. Press the F2 button to select **[Enter]**. Notice the action has been processed and a message appears on the display 'FARE activated' or 'FARE deactivated'.

## How to manually Disable / Enable FARE

The FARE interface can be manually Enable or Disable to stop signal to Fire Alarm Routing Equipment and to prevent signal to Alarm Receiving Centre.



**Do not use Sector disablement to disable FARE.**

Select from the panel menu:

- a. Press the **MENU ON/OFF** key.
- b. Press the F1 button to select **[Control]**.
- c. Press the F4 button to select **[UserCode]**. At the flashing cursor using the keypad input your PIN code and then press the **Enter** button.
- d. To disable or enable FARE: Press the F2 button to select **[Disable] FARE** or press the F1 button to select **[Enable] FARE**.
- e. Momentarily press the F4 button to select **<etc>** until **[FARE]** option is displayed.
- f. Press the F1 button to select **[FARE]**.
- g. Press the F2 key to select **[Enter]**, the display shows either 'FARE Disabled' or 'FARE Enabled' message.

## How to manually Disable / Enable FPE

All the FPE interfaces in a system that signal to all fire protection equipment can be manually disabled or enabled.

Select from the panel menu:

- a. Press the **MENU ON/OFF** key.
- b. Press the F1 button to select **[Control]**.
- c. Press the F4 button to select **[UserCode]**. At the flashing cursor using the keypad input your PIN code and then press the **Enter** button.
- d. To disable or enable FARE: Press the F2 button to select **[Disable] FPE** or press the F1 button to select **[Enable] FPE**.
- e. Momentarily press the F4 button to select **<etc>** until **[FPE]** option is displayed.
- f. Press the F2 button to select **[FPE]**.
- g. Press the F2 key to select **[Enter]**, the display shows either 'FPE Disabled at Card 1' or 'FPE Enabled at Card 1' message is displayed.

## How to enable/disable an IO line

 These operations are not applicable for a Network Node.

An interface input/output line can be disabled or enabled. You will need to know the IO line, device and loop numbers, these numbers can be found in the site specific documents held by the person responsible for the fire system.



**An output line of an interface unit may be assigned to a sector and can only be disabled by disabling that sector. This has the effect of also disabling all other devices in the sector.**

- a. Press the **MENU ON/OFF** key.
- b. Press the F1 button to select **[Control]**.
- c. Press the F4 button to select **[UserCode]**. At the flashing cursor using the keypad input your PIN code and then press the **Enter** button.
- d. To disable an IO line press the F2 button to select **[Disable]** or press the F1 button to select **[Enable]**, the display reads 'Enable' or 'Disable'.
- e. Press the F2 button to select **[IO Line]**. At the flashing cursor using the keypad input an IO line number.
- f. Press the F2 button to select **[Device]**. At the flashing cursor using the keypad input a device number from a range 1 to 200.
- g. Press the F2 button to select **[Loop]**. At the flashing cursor using the keypad input a loop number from a range 1 to 2.
- h. Press the F2 button to select **[Enter]**. Notice the action has been processed and a message appears on the display: 'IO line disabled/enabled at Card n'. The disablement light will illuminate upon disablement of an IO line.

## How to enable/disable auxiliary relay

The control panel / network node has two auxiliary relays that provides voltage free contacts to control external equipment in the event of a fire or fault condition. The operation of the relays can be disabled or enabled.

- a. Press the **MENU ON/OFF** key.
- b. Press the F1 button to select **[Control]**.
- c. Press the F4 button to select **[UserCode]**. At the flashing cursor using the keypad input your PIN code and then press the **Enter** button.
- d. To disable the auxiliary relay press the F2 button to select **[Disable]** or press the F1 button to select **[Enable]**. This puts 'Disable' or 'Enable' on the display.
- e. Press the F4 button three times selecting **<etc>** on each occasion and then press the F2 button to select **[Aux Rly]**. At the flashing cursor using the keypad input an auxiliary relay number or range (1-2).
- f. Press the F2 button to select **[Enter]**. Notice the action has been processed and a message appears on the display: 'Aux Rly n disabled/enabled'. The Disablement light will illuminate upon disablement of an auxiliary relay.

## Other enable/disable options

There are other options such as Sounders, Command Build, Group, and Communication that are accessible for enablement and disablement, for further advice contact your servicing organisation, see the Log book for contact details.

## How to view a device label

**NA** This operation is not applicable for a Network Node.

Each device in the system is given a location label at the time the system is commissioned to identify its installation position. To view a device label you will need to know the device address and the loop on which it resides, which can be found in the site specific documentation held by the person responsible for the fire alarm system.

- a. Press the **MENU ON/OFF** button.
- b. Press the F3 button to select **[Info]**. *Ignore step c. if an external printer is not fitted or is switched off.*
- c. To display a device label press the F1 button to select **[Display]** or to print a device label press the F2 button to select **[Print]**. Notice 'Display' or 'Print' appears on the screen.
- d. Press the F4 button to select **<etc>**.
- e. Press the F2 button to select **[Label]**. Notice 'Label' appears on the display.
- f. Press the F3 button to select **[Device]**. Notice 'Device' followed by a flashing cursor appears on the display. Use the keypad to input a Device number or range (1-200).
- g. Press the F2 button to select **[Loop]**. Notice 'Loop' followed by a flashing cursor appears on the display. Use the keypad to input a loop number (1 or 2).
- h. Press the F2 button to select **[Enter]**. Notice the selected label information is either displayed or printed.

## How to view a zone label

**NA** This operation is not applicable for a Network Node.

A zone is a subdivision of a building used for fire detection. To view a zone label you will need to know the zone number. You can find this information in the site specific documentation, held by the person responsible for the fire alarm system.

- a. Press the **MENU ON/OFF** button.
- b. Press the F3 button to select **[Info]**. *Ignore step c. if an external printer is not fitted or is switched off.*
- c. To display a zone label press the F1 button to select **[Display]** or to print a zone label press the F2 button to select **[Print]**. Notice 'Display' or 'Print' appears on the screen.
- d. Press the F4 button to select **<etc>**.
- e. Press the F2 button to select **[Label]**. Notice 'Label' appears on the display.
- f. Press the F4 button once to select **<etc>**.
- g. Press the F1 key to select **[Zone]**. Notice 'Zone' followed by a flashing cursor appears on the display. Use the keypad to input a Zone number from a range 1-128.
- h. Press the F2 key to select **[Enter]**. Notice the selected label information is either displayed or printed.

## How to view a I/O line label

**NA** This operation is not applicable for a Network Node.

An interface unit can have up to four input/output (IO) lines. Each line may have been given a label for display during an event. To view an IO line label you will need to know the interface device address, the IO line number and the loop number, which can found in the site specific documentation held by the person responsible for the fire alarm system.

- a. Press the **MENU ON/OFF** button.
- b. Press the F3 button to select **[Info]**. *Ignore step c. if an external printer is not fitted or is switched off.*
- c. To display an I/O line label press the F1 button to select **[Display]** or to print an I/O line label press the F2 button to select **[Print]**. Notice 'Display' or 'Print' appears on the screen.
- d. Press the F4 button to select **<etc>**.
- e. Press the F2 button to select **[Label]**. Notice 'Label' appears on the display.
- f. Press the F2 button to select **[IO Line]**. Notice 'IO Line' followed by a flashing cursor appears on the display. Use the keypad to enter an input/output line number from a range 1 to 4.
- g. Press the F2 button to select **[Device]**. Notice 'Device' followed by a flashing cursor on the display. Use the keypad to enter a Device number (1-200).
- h. Press the F2 button to select **[Loop]**. Notice 'Loop' followed by a flashing cursor appears on the display. Use the keypad to input a loop number (1 or 2).
- i. Press the F2 button to select **[Enter]**. Notice the selected label information is either displayed or printed.

## How to view the local panel label

When there is a network of control panels and nodes connected together in a system then each panel/node is usually given an identification label, also referred to as the Local panel label.

- a. Press the **MENU ON/OFF** button.
- b. Press the F3 button to select **[Info]**. *Ignore step c. if an integral printer is not fitted or is switched off.*
- c. To display a local panel label press the F1 button to select **[Display]** or to print a local panel label press the F2 button to select **[Print]**. Notice 'Display' or 'Print' appears on the screen.
- d. Press the F4 button to select **<etc>**.
- e. Press the F2 button to select **[Label]**. Notice 'Label' appears on the display.
- f. Press the F4 button once to select **<etc>**.
- g. Press the F2 key to select **[Local]**. Notice 'Local' appears on the display.
- h. Press the F2 key to select **[Enter]**. Notice the selected label information is either displayed or printed.

## To view or print a map

**NA** The **[Loop map]** option is not applicable for Network Node.

A map provides information on devices that are connected to a loop off a control panel in a fire alarm network.

- a. Press the **MENU ON/OFF** button.
- b. Press the F3 button to select **[Info]**. *Ignore step c. if an integral printer is not fitted or is switched off.*
- c. To display a loop map press the F1 button to select **[Display]** or to print a loop map press the F2 button to select **[Print]**. Notice 'Display' or 'Print' appears on the screen.
- d. Press the F4 button to select **<etc>**.
- e. Press the F4 button to select **[UserCode]**. Notice a message on the display 'Enter access code', followed by a flashing cursor. Use the keypad to input your PIN and then press Enter button.
- f. Press the F3 button to select **[Loop Map]** or **[Map]**.
- g. On selecting **[Map]** you have a choice of either **[Loop Map]** or **[Net Map]**.
- h. On selecting **[Loop Map]** notice 'Loop Map' followed by a flashing cursor appear on the display.
- i. On selecting **[Net Map]** notice 'Node' followed by a flashing cursor appear on the display.
- j. Use the keypad to enter the loop number or node number and then press F3 to select **[Enter]**. Notice the map is either printed or displayed.

## Editing labels



**Any changes to labels must be backed up to the Memory, see the section 'How to save changes to the memory'.**

## How to edit a device label



This operation is not applicable for a Network Node.

There can be up to 200 devices connected to a loop, devices like fire sensors and manual call points. Each device can be given a label to identify its location in the system. Devices in your system may have already been given labels and these labels can be changed. To edit a device label you will need to know the device number and the loop on which it resides. You can find this information in the site specific documentation, held by the person responsible for the fire system.

- a. Press the **MENU ON/OFF** button
- b. Press the F2 button to select **[Set Up]**.
- c. Press the F4 button to select **[UserCode]**. A message is displayed: 'Enter access code' followed by a flashing cursor. Use the keypad to input your PIN and then press the Enter button.
- d. Press the F4 button once to select **<etc>**.
- e. Press the F1 button to select **[Modify]**. Notice 'Modify' appears on the display.
- f. Press the F1 button to select **[Label]**. Notice 'Label' appears on the display.
- g. Press the F3 button to select **[Device]**. Notice 'Device' followed by a flashing cursor appears on the display.
- h. Use the keypad to input a Device number.
- i. Press the F2 button to select **[Loop]**. Notice 'Loop' followed by a flashing cursor on the display. Use the keypad to input a loop number either 1 or 2.
- j. Press the F2 button to select **[Enter]**. Notice the previous label appears on the display with a flashing first character to prompt the modification, if there is no label the line is blank.
- k. Use the keypad to enter a label of up to 32 characters in length (28 for MCP) and then press the **Enter** button.



## How to edit an Input/output line label

**NA** This operation is not applicable for a Network Node.

Each input / output (IO) line of an interface unit can be given a label and a previously entered label can be modified. To edit an IO line label you will need to know the IO line number, interface device number and the loop number it is connected to. You can find this information in the site specific documentation, held by the person responsible for the fire alarm system.

- a. Press the **MENU ON/OFF** button.
- b. Press the F2 button to select **[Set Up]**.
- c. Press the F4 button to select **[UserCode]**. Notice a message on the display 'Enter access code', followed by a flashing cursor. Use the keypad to input your PIN and then press **Enter** button.
- d. Press the F4 button once to select **<etc>**.
- e. Press the F1 button to select **[Modify]**. Notice 'Modify' appears on the display.
- f. Press the F1 button to select **[Label]**. Notice 'Label' appears on the display.
- g. Press the F2 button to select **[IO Line]**. Notice 'IO Line' followed by a flashing cursor on the display. Using the keypad enter an input/output number from a range 1 to 4.
- h. Press the F3 button to select **[Device]**. Notice 'Device' followed by a flashing cursor appears on the display. Use the keypad to input a Device number from the range 1 to 200.
- i. Press the F2 button to select **[Loop]**. Notice 'Loop' followed by a flashing cursor on the display. Use the keypad to input a loop number 1 or 2.
- j. Press the F2 button to select **[Enter]**. Notice the previous label appears on the display with a flashing first character to prompt you to edit a label. If there is no label then the line is blank.
- k. Using the keypad enter a label of up to 32 characters in length and then press the **Enter** button.

### How to edit a zone label



This operation is not applicable for a Network Node.

Each zone can be given a label and an entered label can be modified. To edit a zone label you will need to know the zone number. You can find this information in the site specific documentation, held by the person responsible for the fire alarm system.

- a. Press the **MENU ON/OFF** button.
- b. Press the F2 button to select **[Set Up]**.
- c. Press the F4 button to select **[UserCode]**. Notice a message on the display 'Enter access code', followed by a flashing cursor. Use the keypad to input your PIN and then press **Enter** button.
- d. Press the F4 button once to select **<etc>**.
- e. Press the F1 button to select **[Modify]**. Notice 'Modify' appears on the display.
- f. Press the F1 button to select **[Label]**. Notice 'Label' appears on the display.
- g. Press the F4 button once to select **<etc>**.
- h. Press the F1 button to select **[Zone]**. Notice 'Zone' followed by a flashing cursor appears on the display. Using the keypad enter a number from a range 1 to 128.
- i. Press the F2 button to select **[Enter]**. Notice the previous label appears on the display with a flashing first character to prompt you to edit the label. If there is no label then the line is blank.
- j. Using the keypad to enter a label of up to 32 characters in length and then press the **Enter** button.

### How to edit a local panel label

A label is normally given to the control panel to identify its location in a network. A previously entered label can be modified.

- a. Press the **MENU ON/OFF** button.
- b. Press the F2 button to select **[Set Up]**.
- c. Press the F4 button to select **[UserCode]**. Notice a message on the display 'Enter access code', followed by a flashing cursor. Use the keypad to input the PIN and then press **Enter** button.
- d. Press the F4 button once to select **<etc>**.
- e. Press the F1 button to select **[Modify]**. Notice 'Modify' appears on the display.
- f. Press the F1 button to select **[Label]**. Notice 'Label' appears on the display.
- g. Press the F4 button once to select **<etc>**.
- h. Press the F2 button to select **[Local]**. Notice 'local' appears on the display.
- i. Press the F2 button to select **[Enter]**. Notice the previous label appears on the display with a flashing first character to prompt you to edit the label. If there is no label then the line is blank.
- j. Using the keypad to enter a label of up to 40 characters in length and then press the **Enter** button.

---

## How to edit custom label

A custom message or label is displayed beneath the Designed to *EN54 Pt 2 & 4* line on the panel. The message or label can be up to 40 characters in length and it can be contact information of the person responsible for the fire alarm system or it can have contact phone number of the servicing organisation. Example: "For service call: phone number".

A previously entered label can be modified.

- a. Press the **MENU ON/OFF** button.
- b. Press the F2 button to select **[Set Up]**.
- c. Press the F4 button to select **[UserCode]**. Notice a message on the display 'Enter access code', followed by a flashing cursor. Use the keypad to input the PIN and then press **Enter** button.
- d. Press the F4 button once to select **<etc>**.
- e. Press the F1 button to select **[Modify]**. Notice 'Modify' appears on the display.
- f. Press the F1 button to select **[Label]**. Notice 'Label' appears on the display.
- g. Press the F4 button once to select **<etc>**.
- h. Press the F3 button to select **[Custom]**. Notice 'Custom' appears on the display.
- i. Press the F2 button to select **[Enter]**. Notice the previous label appears on the display with a flashing first character to prompt you to edit a label. If there is no label then the line is blank.
- j. Using the keypad enter a label of up to 40 characters in length and press the **Enter** button.

## Maintenance

### Replacing the glass on a Manual Call Point

a. Disengage the front cover from the call point assembly using the end of the test key. Insert the key into the slots 'E' on the underside of the call point to compress the retaining tabs and the from the bottom edge lift out the cover.

b. Carefully remove broken glass from the call point.



**Take appropriate precautions when clearing the broken glass to prevent injury.**

c. Insert the key in the keyhole and turn the key such that the tab is at position 'F' and then insert a new glass as shown. Ensure the glass has engaged into the yellow arm.

d. Hook the front cover onto the top edge of the call point assembly and then push the bottom edge down until a click is heard and the cover shuts onto the main assembly. Check both hooks on the top of the front cover are locked onto the call point assembly.

e. Turn the test key anticlockwise one quarter of a turn such that the glass is held under the yellow arm. The call point is now ready for normal operation.

S4-34891 Spare MCP glass (Pack of 10)

### Resetting the resetable element on a Manual Call Point

Slide the keyhole cover upwards to expose the keyhole. Insert the test key in the keyhole and turn it clockwise by one quarter of a turn. Then turn the test key anticlockwise by one quarter of a turn to reset the call point element.

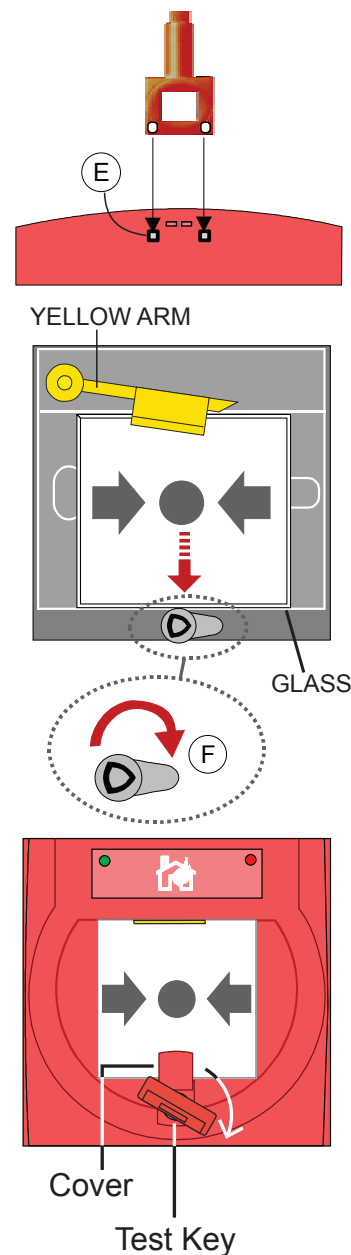

## Battery replacement

It is recommended where batteries are installed they are replaced at 4 Yearly intervals from the date the system is first commissioned.



**Any servicing work on the system must be carried out by a suitably trained person, such as an engineer from the servicing organisation.**

## Replacing printer paper

The printer paper roll is located on the inside of the inner door. A vertical line on the paper indicates the end of paper.

VS-PROLL Replacement paper roll

- Open the panel outer door using the key supplied and then open inner door using the allen key/flat ended screw driver dependent on panel construction.
- Remove the old paper roll from inside of the inner door assembly. Where the paper roll holder is vertically above the mechanism then do : d), e) and then c).
- Fit the new paper roll to the holder.
- Insert paper from the new paper roll into the printer mechanism.
- Turn the paper feed wheel located on the outside of the inner door downwards to feed paper thru the print mechanism and out.
- Close the inner door and lock it.
- Carry out a printer paper test, see panel controls section of this manual.
- Close the outer door and lock it.

Choose the paper roll feed appropriate for your panel

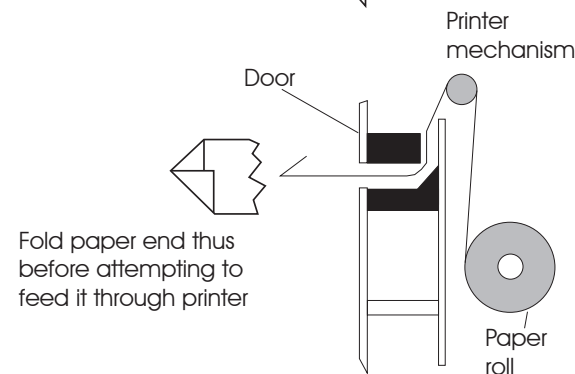
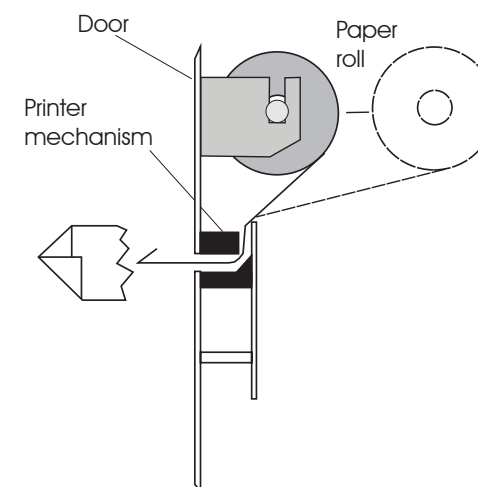

## Repair function

**NA** This operation is not applicable for a Network Node.

Any wiring fault on the system must be rectified by an engineer from the servicing organisation, for contact details see the log book. A wiring fault will require correction to the wiring before running a **[Repair]** command at the main panel.

The repair function is accessible using customer (level 2) password, however under normal circumstances it is unnecessary to use this function.

- a. Press the **MENU ON/OFF** key.
- b. Press the F1 button to select **[Test/Eng]**.
- c. Press the F4 button to select **[UserCode]**. Notice a flashing cursor and a message on the display 'Enter access code'. Use the keyboard to input your password and then press the **Enter** button.
- d. Press the F1 button to select **[Loop]** and F1 button to select **[Repair]** notice 'Loop' followed by a flashing cursor on the display. Use the keypad to input a loop number 1 or 2 and then press the F2 button to select **[Enter]**.

This page has been intentionally left blank.



0832

**Gent by Honeywell (Novar Systems Limited)**  
**Manufactured by: Honeywell Life Safety Systems,**  
**140 Waterside Road, Hamilton Industrial Park,**  
**Leicester, LE5 1TN, United Kingdom**

13

DoP	Product No.
026-CPR-2013	VIG1-24
026-CPR-2013	VIG1-24-NP
026-CPR-2013	VIG1-24-PO
026-CPR-2013	VIG1-24-SP
027-CPR-2013	VIG1-72
027-CPR-2013	VIG1-72-PO
027-CPR-2013	VIG1-72-SP

EN54-2: 1997 + A1:2006, EN54-4: 1997 + A1: 2002 + A2: 2006

Vigilon VIG1-24	(EN54-2 & 4)
Vigilon VIG1-24-NP	(EN54-2 & 4)
Vigilon VIG1-24-PO	(EN54-2 & 4)
Vigilon VIG1-24-SP	(EN54-2 & 4)

Vigilon VIG1-72	(EN54-2 & 4)
Vigilon VIG1-72-PO	(EN54-2 & 4)
Vigilon VIG1-72-SP	(EN54-2 & 4)

**Intended for use in fire detection and fire alarm systems  
in and around buildings**

Refer to DOP 026-CPR-2013 & 027-CPR-2013 for level or class of  
performance declared, for details see website [www.gent.co.uk](http://www.gent.co.uk)



**WEEE Directive:**

At the end of their useful life, the packaging, product  
and batteries should be disposed of via a suitable  
recycling centre.  
Do not dispose of with your normal household waste.  
Do not burn.



**At the end of their useful life, the packaging,  
product and batteries should be disposed of  
via a suitable recycling centre and in  
accordance with national or local legislation.**

Gent by Honeywell reserves the right to revise this publication from time to time and make changes to the content hereof without obligation to notify any person of such revisions of changes.

**GENT**  
by Honeywell

Hamilton Industrial Park, Waterside Road, Leicester LE5 1TN

Telephone: +44 (0) 116 246 2000

Technical support: [www.gentexpert.co.uk](http://www.gentexpert.co.uk)

Website: [www.gent.co.uk](http://www.gent.co.uk)

Fax (UK): 44 (0) 116 246 2300